

SUKU KATA 13

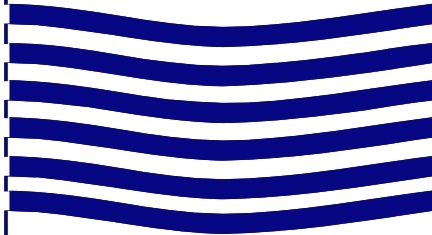

www.saujana.sg



OLEH : MOHAMED NAIM DAIFI

Nama saya :

Darjah :

Sekolah :

baca

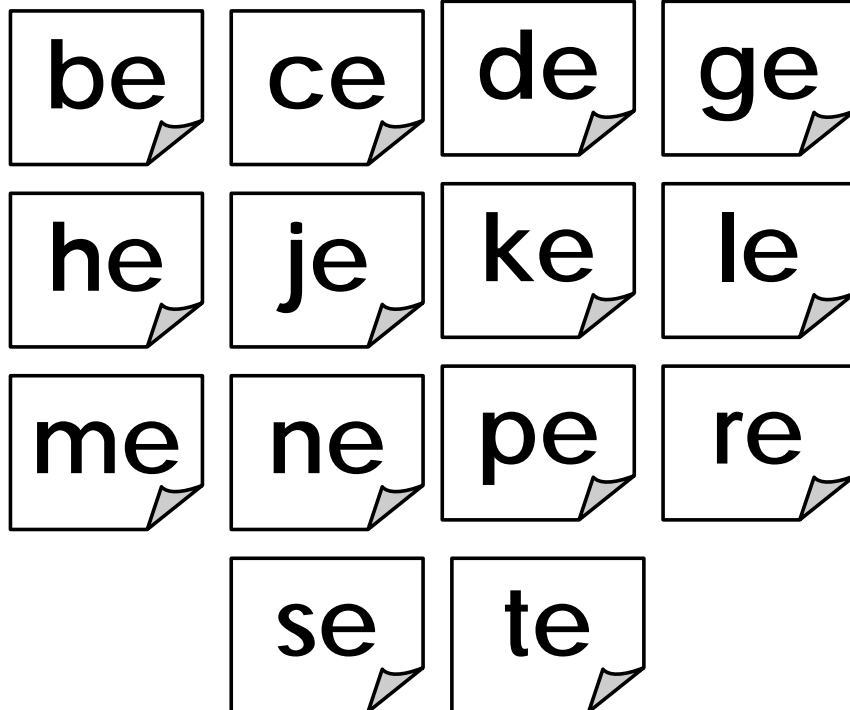



be



be



be



ke

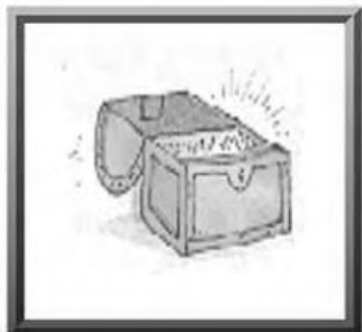

pe



pe ti



pe ti

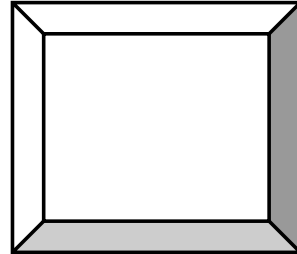

pe ti

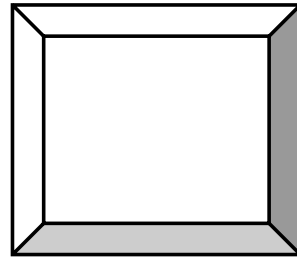

be

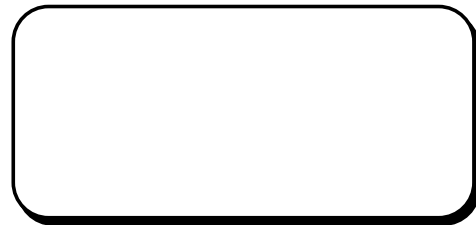

be

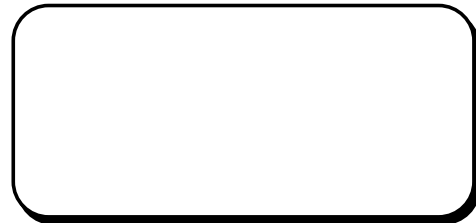

ke





e



be



be



de

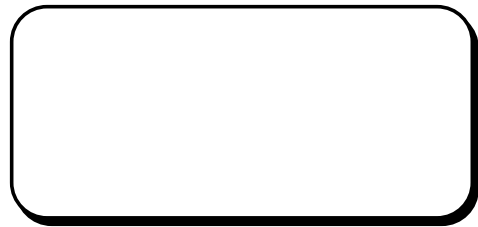



ge



ge



ke



ke



re



le



pe



he



ge

ben

hen

ken

men

ber

cer

per

mer

sen

jen

ten

ren

der

ker

ser

ter



gen

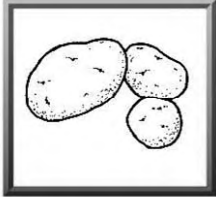

ken



ben







lem

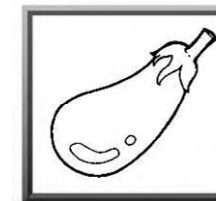











sen









te



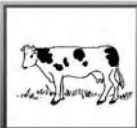

	be	1	A	tis
	be	2	B	si
	be	3	C	tik
	be	4	D	ri
	be	5	E	li

	be	1	A	tik
	be	2	B	ris
	pe	3	C	dak
	pe	4	D	ras
	ke	5	E	ti

	pe	1	A	tir
	ge	2	B	ram
	ge	3	C	mam
	ke	4	D	las
	de	5	E	las

	le	1	A	bu
	re	2	B	tam
	ke	3	C	bah
	lem	4	D	ban

	ge	1	A	dang
	pe	2	B	rung
	he	3	C	lang
	te	4	D	lang

	gen	1	A	duk
	ken	2	B	dang
	sen	3	C	tang
	ben	4	D	dang

Baca:



Emak meng_____ keropok.
_____ itu keropok udang.
Keropok itu _____.

Baca:



Raju hendak ber_____ dengan doktor.
_____ Raju sakit.
Semalam, seekor _____ masuk ke
dalam _____ Raju.